

KINGSTON BRASS

THE TRADITION OF FINE BRASS

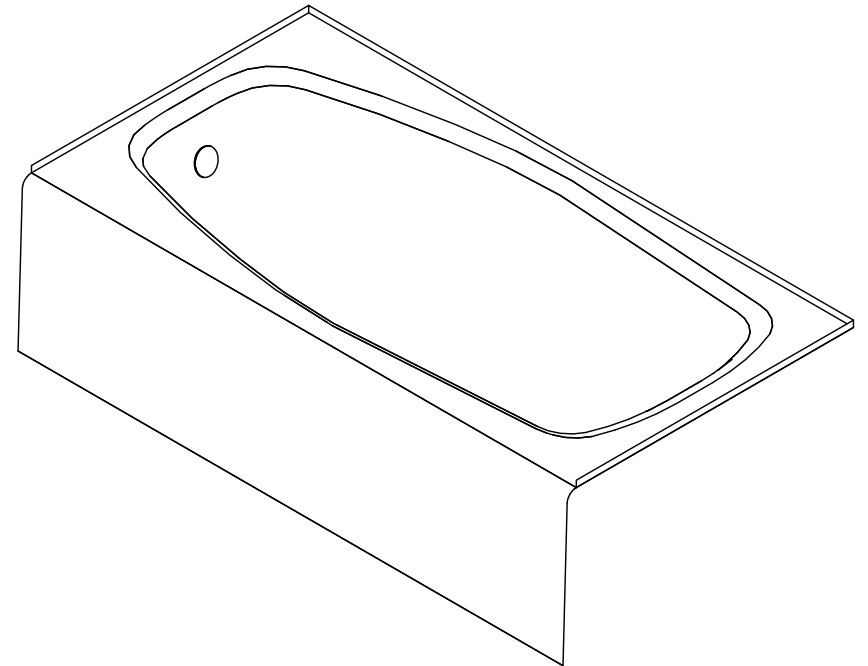

www.kingstonbrass.com

TOLL-FREE CUSTOMER SERVICE: 1-877-2-KBRASS

TECHNICAL SUPPORT E-mail: service@kingstonbrass.com

12775 Reservoir Street, Chino, CA91710

INSTALLATION INSTRUCTIONS

For Use With KB's Bath Tub with or without Drain

Important points to remember before beginning installation:

- Verify that floor is structurally sound and level, floor must be able to support the full load of the tub including water to the overflow level.
- Provide access to all plumbing connections
- Observe all local building and plumbing codes

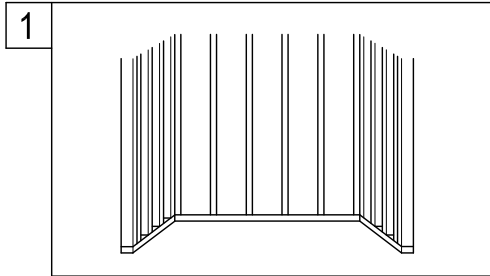

1. Prepare area by framing the area where the tub will be installed.

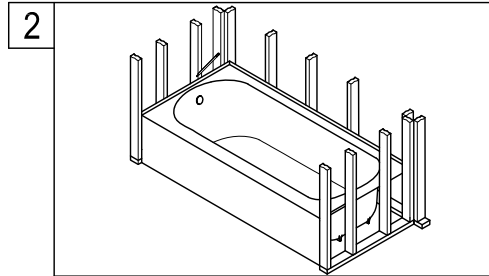

2. Place the tub at the location where the tub will be installed, level tub on all sides and mark the location of the drain and the wall studs on the tile flange.

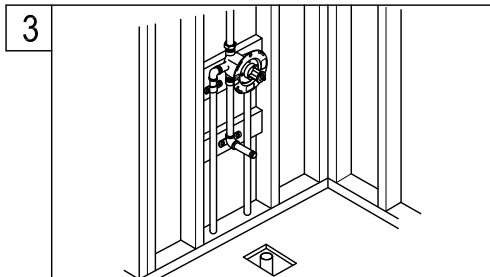

3. Remove tub and install the drain, pre-drill holes on tile flange at the marked location of the studs.

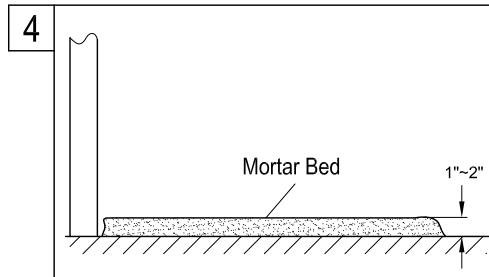

4. Apply a thin layer (1" to 2") of mortar mix cement to the area where your tub basin will be sitting.

Need Tools:

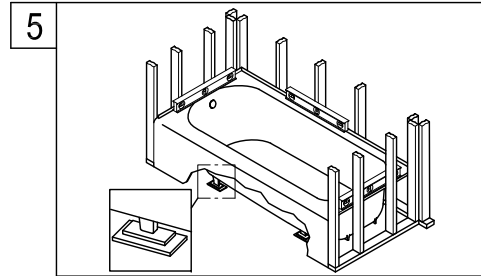
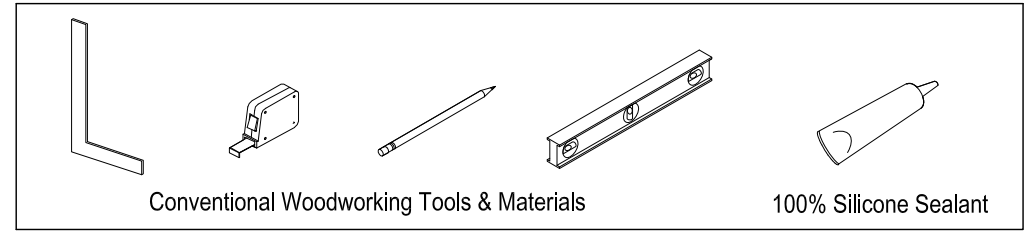

5. Move tub into place, make sure the tub is level and plumb adjust feet or shim as necessary

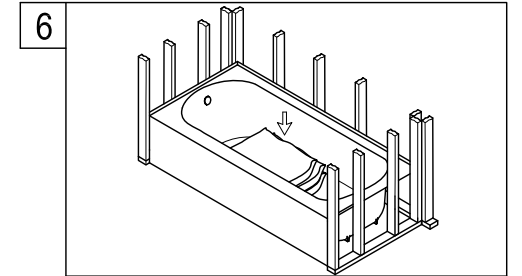

6. Secure to the wall with galvanized screws at the predrilled screw location, apply weight to the middle of the tub until the mortar sets.

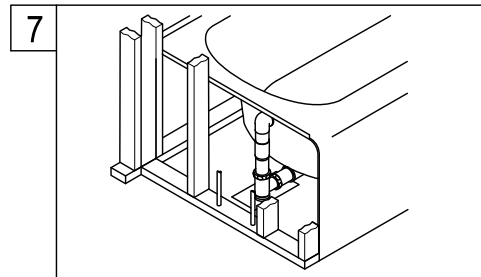

7. Connect the tub drain to your drain system.

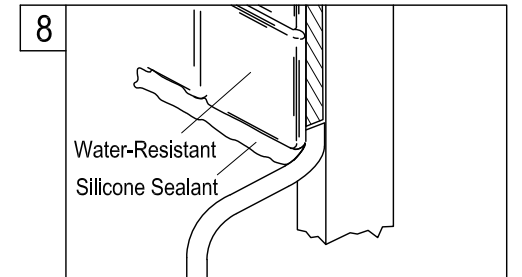

8. Install water resistant gypsum board and finish surface material (tile, stone) and seal all edges with silicone caulking to prevent water damage.

Cleaning

Clean with a damp cloth only.
Avoid using metal or abrasive polishes.